

English

TOSHIBA

OWNER'S MANUAL

DLP™ PROJECTOR

TDP-MT200

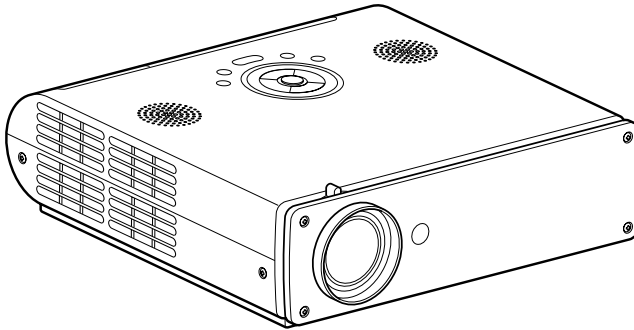

Before Using

Preparations

Operations

Maintenance

Others

SAFETY PRECAUTIONS



The lightning flash with arrowhead symbol, within an equilateral triangle, is intended to alert the user to the presence of uninsulated "dangerous voltage" within the product's enclosure that may be of sufficient magnitude to constitute a risk of electric shock to persons.



The exclamation point within an equilateral triangle is intended to alert the user to the presence of important operating and maintenance (servicing) instructions in the literature accompanying the appliance.

WARNING: TO REDUCE THE RISK OF FIRE OR ELECTRIC SHOCK, DO NOT EXPOSE THIS APPLIANCE TO RAIN OR MOISTURE. DANGEROUS HIGH VOLTAGES ARE PRESENT INSIDE THE ENCLOSURE. DO NOT OPEN THE CABINET. REFER SERVICING TO QUALIFIED PERSONNEL ONLY.

WARNING: Handling the cord on this product or cords associated with accessories sold with this product, will expose you to lead, a chemical known to the State of California to cause birth defects or other reproductive harm. ***Wash hands after handling.***

WARNING: This [product] contains mercury. Disposal of mercury may be regulated due to environmental considerations. For disposal or recycling information, please contact your local authorities or the Electronic Industries Alliance: www.eiae.org.

MODEL NAME: TDP-MT200 **USA only**

| | |
|--|-----------------------|
| TRADE NAME: DLP™ PROJECTOR | MODEL NAME: TDP-MT200 |
|  Tested To Comply With FCC Standards | |
| FOR HOME OR OFFICE USE | |

FCC NOTICE: This device complies with part 15 of the FCC Rules. Operation is subject to the following two conditions:

(1) This device may not cause harmful interference, and (2) this device must accept any interference received, including interference that may cause undesired operation.

This equipment has been tested and found to comply with the limits for a Class B digital device, pursuant to part 15 of the FCC Rules. These limits are designed to provide reasonable protection against harmful interference in a residential installation. This equipment generates, uses and can radiate radio frequency energy and, if not installed and used in accordance with the instructions, may cause harmful interference to radio communications.

However, there is no guarantee that interference will not occur in a particular installation.

If this equipment does cause harmful interference to radio or television reception, which can be determined by turning the equipment off and on, the user is encouraged to try to correct the interference by one or more of the following measures:

- Reorient or relocate the receiving antenna.
- Increase the separation between the equipment and receiver.
- Connect the equipment into an outlet on a circuit different from that to which the receiver is connected.
- Consult the dealer or an experienced radio/TV technician for help.

RESPONSIBLE PARTY: Toshiba America Consumer Products LLC
82 Totowa Road, Wayne, New Jersey, 07470
Phone: (973)628-8000

WARNING: Changes or modifications made to this equipment, not expressly approved by Toshiba, or parties authorized by Toshiba, could void the user's authority to operate the equipment.

USA only

Notice: This Class B digital apparatus complies with Canadian ICES-003. Cet appareil numérique de la classe B est conforme à la norme NMB-003 du Canada.

CANADA only

IMPORTANT SAFETY INSTRUCTIONS

CAUTION: PLEASE READ AND OBSERVE ALL WARNINGS AND INSTRUCTIONS GIVEN IN THIS OWNER'S MANUAL AND THOSE MARKED ON THE UNIT. RETAIN THIS BOOKLET FOR FUTURE REFERENCE.

This set has been designed and manufactured to assure personal safety. Improper use can result in electric shock or fire hazard. The safeguards incorporated in this unit will protect you if you observe the following procedures for installation, use and servicing. This unit is fully transistorized and does not contain any parts that can be repaired by the user.

DO NOT REMOVE THE CABINET COVER, OR YOU MAY BE EXPOSED TO DANGEROUS VOLTAGE. REFER SERVICING TO QUALIFIED SERVICE PERSONNEL ONLY.

1. Read Owner's Manual

After unpacking this product, read the owner's manual carefully, and follow all the operating and other instructions.

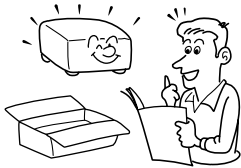

3. Source of Light

Do not look into the lens while the lamp is on. The strong light from the lamp may cause damage to your eyes or sight.

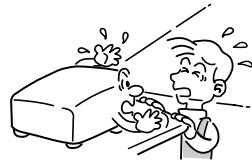

2. Power Sources

This product should be operated only from the type of power source indicated on the marking label.

If you are not sure of the type of power supply to your home, consult your product dealer or local power company.

For products intended to operate from battery power, or other sources, refer to the operating instructions.



4. Ventilation

Openings in the cabinet are provided for ventilation and to ensure reliable operation of the product and to protect it from overheating, and these openings must not be blocked or covered. The openings should never be blocked by placing the product on a bed, sofa, rug or other similar surface. This product should not be placed in a built-in installation such as a bookcase or rack unless proper ventilation is provided or the manufacturer's instructions have been adhered to.



5. Heat

The product should be situated away from heat sources such as radiators, heat registers, stoves, or other products (including amplifiers) that produce heat.

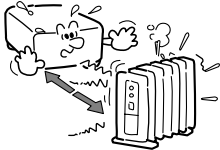

6. Water and Moisture

Do not use this product near water. - for example, near a bath tub, wash bowl, kitchen sink, or laundry tub; in a wet basement; or near a swimming pool and the like.

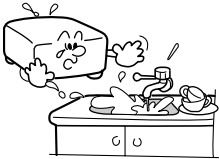

7. Cleaning

Unplug this product from the wall outlet before cleaning. Do not use liquid cleaners or aerosol cleaners. Use a soft cloth for cleaning.

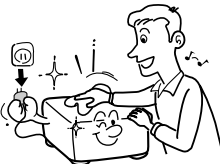

8. Power-Cord Protection

Power-supply cords should be routed so that they are not likely to be walked on or pinched by items placed upon or against them, paying particular attention to cords at plugs, convenience receptacles, and the point where they exit from the product.



9. Overloading

Do not overload wall outlets; extension cords, or integral convenience receptacles as this can result in a risk of fire or electric shock.



IMPORTANT SAFETY INSTRUCTIONS (Continued)

10. Lightning storms

For added protection for this product during storm, or when it is left unattended and unused for long periods of time, unplug it from the wall outlet. This will prevent damage to the product due to lightning and power-line surges. However, while it is thundering or lightning, do not touch the apparatus and any connected cable and/or equipment. This will prevent you from receiving the electric shock by an electric surge.



11. Object and Liquid Entry

Never push objects of any kind into this product through openings as they may touch dangerous voltage points or short-out parts that could result in a fire or electric shock. Never spill liquid of any kind on the product.



12. Do not place the product vertically

Do not use the product in the upright position to project the pictures at the ceiling, or any other vertical positions. It may fall down and dangerous.

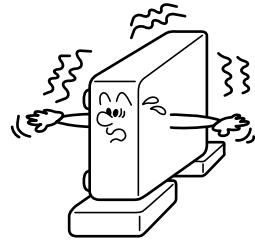

13. Stack Inhibited

Do not stack other equipment on this product or do not place this product on the other equipment. Top and bottom plates of this product develops heat and may give some undesirable damage to other unit.

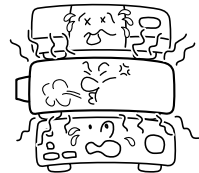

14. Attachments

Do not use attachments not recommended by the product manufacturer as they may cause hazards.

15. Accessories

Do not place this product on an unstable cart, stand, tripod, bracket, or table. The product may fall, causing serious injury to a child or adult, and serious damage to the product. A product and cart combination should be moved with care. Quick stops, excessive force, and uneven surfaces may cause the product and cart combination to overturn.



S3125A

16. Damage Requiring Service

Unplug this product from the wall outlet and refer servicing to qualified service personnel under the following conditions:

- When the power-supply cord or plug is damaged.
- If liquid has been spilled, or objects have fallen into the product.
- If the product has been exposed to rain or water.
- If the product does not operate normally by following the operating instructions. Adjust only those controls that are covered by the operating instructions as an improper adjustment of other controls may result in damage and will often require extensive work by a qualified technician to restore the product to its normal operation.

- If the product has been dropped or damaged in any way.
- When the product exhibits a distinct change in performance - this indicates a need for service.

17. If glass components, including lens and lamp, should break, contact your dealer for repair service.

This product incorporates glass components, including a lens and a lamp. If such parts should break, please handle with care to avoid injury and contact your dealer for repair service. The broken pieces of glass may cause injury. In the unlikely event of the lamp rupturing, thoroughly clean the area around the projector and discard any edible items placed in that area.

18. Servicing

Do not attempt to service this product yourself as opening or removing covers may expose you to dangerous voltage or other hazards. Refer all servicing to qualified service personnel.



IMPORTANT SAFETY INSTRUCTIONS (Continued)

19. Replacement Parts

When replacement parts are required, be sure the service technician has used replacement parts specified by the manufacturer or have the same characteristics as the original part. Unauthorized substitutions may result in fire, electric shock, or other hazards.

(Replacement of the lamp only should be made by users.)

20. Safety Check

Upon completion of any service or repairs to this product, ask the service technician to perform safety checks to determine that the product is in proper operating condition.



21. Do not leave thermal-paper documents or easily deformed items on top of the unit or near the air exhaust for long periods of time.

The heat from the unit could erase the information on the thermal paper, or cause deformation or warping.

22. Do not use the product in a closed installation state.

Do not place the product in a box or in any other closed installation state. Otherwise it may overheat. This could result in a risk of fire.

POWER SUPPLY CORD SELECTION

If your line voltage is 220 to 240V, use one of the following types of cable.

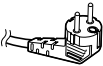
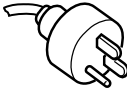
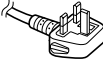
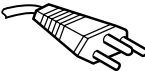
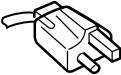
| Plug configuration | Plug type | Line voltage | Plug configuration | Plug type | Line voltage |
|--|-----------|--------------|---|-------------------------------|--------------|
|  | EURO | 220 – 240V |  | Australian 240V 10A | 200 – 240V |
|  | UK | 220 – 240V |  | Switzerland 240V 6A | 200 – 240V |
| Use a 5A fuse which is approved by ASTA or BSI to BSI362. Always replace the fuse cover after changing the fuse. | | |  | North American 240V 15A | 200 – 240V |

IMPORTANT PRECAUTIONS

Save Original Packing Materials

The original shipping carton and packing materials will come in handy if you ever have to ship your projector. For maximum protection, repack the set as it was originally packed at the factory.

Moisture Condensation

Never operate this unit immediately after moving it from a cold location to a warm location. When the unit is exposed to such a change in temperature, moisture may condense on the crucial internal parts. To prevent the unit from possible damage, do not use the unit for at least 2 hours when there is an extreme or sudden change in temperature.

Place and Manner of Installation

- Do not place in hot locations, such as near heating equipment. Doing so could cause malfunction, and shorten the life of the projector.
- Avoid locations with oil or cigarette smoke. Doing so will dirty the optical parts, shortening their lives, and darkening the screen.
- Do not use the product vertically in any upright position or slantwise in an angle of 20 degrees or more.
- Using this instrument near a TV or radio may cause interference to the images or audio sound. If this happens, move it away from the TV or radio.
- Moving the projector from a low-temperature room to a high-temperature room may cause condensation on the lens or internal parts in the instrument. If you continue to use it in that situation, the malfunction may result. Ensure to wait until the condensation naturally disappears.
- In a high altitude location where air is thin, cooling efficiency is reduced so use it with the ambient temperature being lowered.

IMPORTANT PRECAUTIONS (Continued)

Avoid Volatile Liquid

Do not use volatile liquids, such as an insect spray, near the unit. Do not leave rubber or plastic products touching the unit for a long time. They will leave marks on the finish. If cleaning with a chemically saturated cloth, be sure to follow the product's precautions.

In the spaces provided below, record the Model and Serial No. located at the bottom of your projector.

Model No. _____ Serial No. _____

Retain this information for future reference.

EXEMPTION CLAUSES

- Toshiba Corporation bears no responsibility in the case of damages arising from natural disaster such as earthquakes, lightning, etc., fire not liable to Toshiba Corporation, operation, theft or mischief by third parties, other accidents, or use under abnormal conditions including erroneous or improper operation and other problems.
- Toshiba Corporation bears no responsibility for incidental damages (lost profit, work interruption, corruption or loss of the memory contents, etc.) arising from the use of or the inability to use this unit.
- Toshiba Corporation accepts no liability whatsoever for any damages arising from not having followed the descriptions in this Instruction Manual.
- Toshiba Corporation accepts no liability whatsoever for any damages arising from malfunctions arising from combination with equipment or software that is not related to Toshiba Corporation.

OTHER CAUTIONS AND INFORMATIONS

Copyrights

Showing or transmitting commercial imaging software or broadcast or cable-broad casting programs with the purpose of other than the personal and private viewing, including modifying images using the freeze or resize functions, or displaying with the varying aspect ratio of the images, could violate the direct or indirect copyrights of the imaging software or broadcast program, etc., if done without first consulting with the copyright holder. For this reason, please take appropriate measures before performing one of the actions listed above, including obtaining a license from the copyright holder.

Disposal

This product contains substances which are harmful to humans and the environment.

- Solder used in the internal parts contains the lead.
- The lamp contains inorganic mercury.

Please dispose of this product or used lamps in accordance with local regulations.

Trademarks

- VGA, SVGA, XGA, SXGA, UXGA are trademarks or registered trademarks of International Business Machines Corporation.
- Digital Light Processing, Digital Micromirror Device and DMD are trademarks of Texas Instruments.
- Macintosh is a registered trademark of Apple Computer, Inc.
- Windows is a registered trademark of Microsoft Corporation in the U.S. and other countries.
- Adobe is a registered trademark and Acrobat Reader is a trademark of Adobe Systems Incorporated.

Notational Conventions Used in This Manual

- References to pages with related information are annotated as follows.
For example, if making a reference to page 36: **p.36**
- The illustrations in this document are for reference purposes only and may not reflect your package exactly.

REMOTE CONTROL BATTERIES

Caution

- Never throw batteries into a fire.

Notes

- Be sure to use AA batteries.
- Dispose of batteries in a designated disposal area.
- Attention should be drawn to the environmental aspects of battery disposal.
- Do not mix different battery types or combine used batteries with new ones.
- If the remote control does not operate correctly, or if the operating range becomes reduced, replace both batteries with new ones.
- If the batteries are dead or if you will not be using the remote control for a long time, remove the batteries to prevent battery acid from leaking into the battery compartment.

Using the batteries improperly may cause them to explode or leak and lead to burn or injury. If battery-leaking fluid contacts skin, wash the fluid off immediately with clean water and consult a doctor. If the fluid is spilt on an instrument, avoid contact and wipe it off using tissue paper. (Dispose of the used tissue paper as flammable garbage after moistening with water.)

CONTENTS

Before Using

| | |
|---------------------------------------|----|
| SAFETY PRECAUTIONS | 2 |
| IMPORTANT SAFETY INSTRUCTIONS | 4 |
| POWER SUPPLY CORD SELECTION | 9 |
| IMPORTANT PRECAUTIONS | 9 |
| EXEMPTION CLAUSES | 10 |
| OTHER CAUTIONS AND INFORMATIONS | 11 |
| REMOTE CONTROL BATTERIES | 11 |
| CONTENTS | 12 |

Preparations

| | |
|--|----|
| Checking the package contents | 14 |
| Names of each part on the main unit | 15 |
| Names of each part on the control panel and remote control | 16 |
| Parts on the rear panel | 17 |
| Preparing and using the remote control | 18 |
| Placement | 19 |
| Connection | 20 |

Operations

| | |
|--|----|
| Turning the power on and off | 21 |
| Basic operations | 23 |
| Using handy features | 25 |
| Using auto setting | 25 |
| Cutting off the picture temporarily (Mute) | 27 |
| Freezing the image (Freeze) | 27 |
| Using the menus | 28 |
| How to use the menus | 28 |
| The image adjustment menu | 29 |
| The display setting menu | 30 |
| The default setting menu | 31 |
| Displaying Information (Status display) | 32 |

Maintenance

| | |
|-----------------------------------|----|
| About lamp | 33 |
| Lamp replacement | 33 |
| Lens and main unit cleaning | 35 |

Others

| | |
|--|----|
| Trouble indications | 36 |
| Before calling service personnel | 37 |
| Specifications | 38 |
| List of general specifications | 38 |
| Separately sold product | 38 |
| List of supported signals (RGB signals) | 39 |
| List of supported signals (DVI signals) | 40 |
| List of supported signals (Y/Pb/Pr signals) | 41 |
| List of supported signals (Video, S-Video signals) | 41 |
| Pin assignment of COMPUTER terminal | 41 |
| Pin arrangement for the DVI-D terminal | 42 |
| CONTROL terminal | 43 |

Checking the package contents

Please make sure that the following items are included in the box, along with the main unit. If any item is missing, please contact the store immediately where you purchased the product.

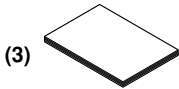
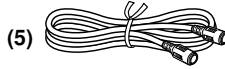
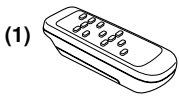

- (1) Remote control
- (2) R6 (SIZE AA) batteries for remote control (2)
- (3) Owner's Manual
- (4) Video cable
- (5) S-Video cable
- (6) Power cord (See note)

Note

The shape and number of supplied power cords vary depending on the product destination.

Names of each part on the main unit

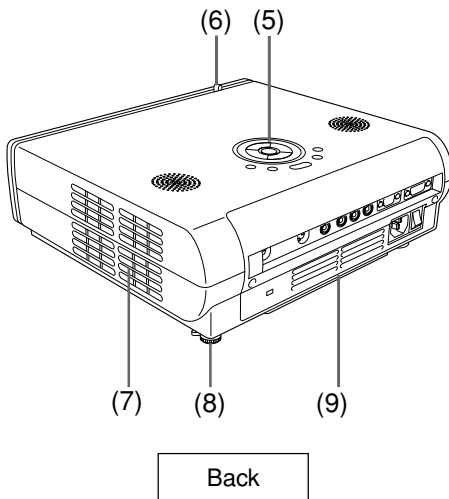

Back

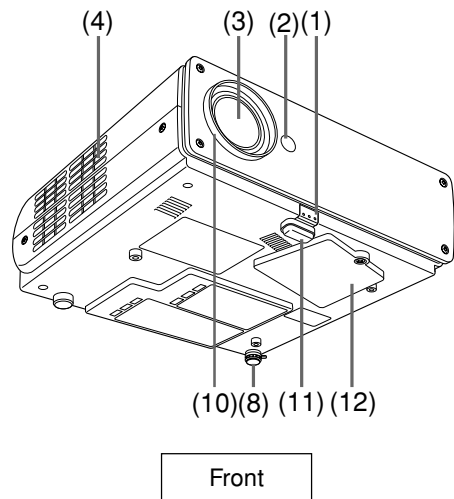

Front

| Name | : Function |
|----------------------------------|---|
| (1) Foot adjuster release button | : Press to stow the foot adjuster. p.24 |
| (2) Infrared remote sensor | : Senses commands from the remote control. p.18 |
| (3) Lens | : Projects expanded image. |
| (4) Air intake | : Draws in air from outside the projector. |
| (5) Control panel | : Operates the projector. p.16 |
| (6) Zooming lever | : Adjusts screen size. p.24 |
| (7) Air exhaust | : Expels air that has grown hot inside the projector. |
| (8) Tilt adjuster | : Adjusts the projector's horizontal tilt. p.24 |
| (9) Rear panel | : Connects external devices. p.17 |
| (10) Focusing lever | : Adjusts screen focus. p.24 |
| (11) Foot adjuster | : Adjusts the vertical projection angle. p.24 |
| (12) Lamp cover | : Remove to replace lamp. p.34 |

Names of each part on the control panel and remote control

Control panel

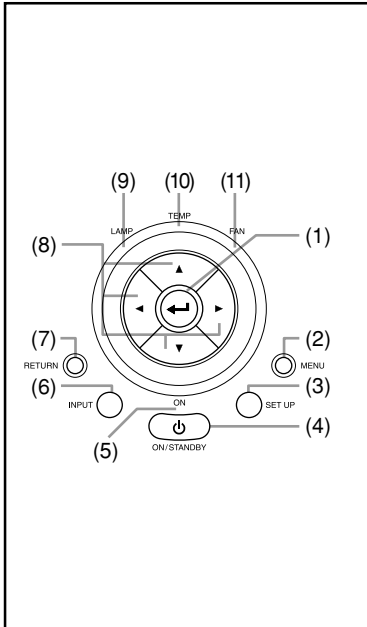

Remote Control

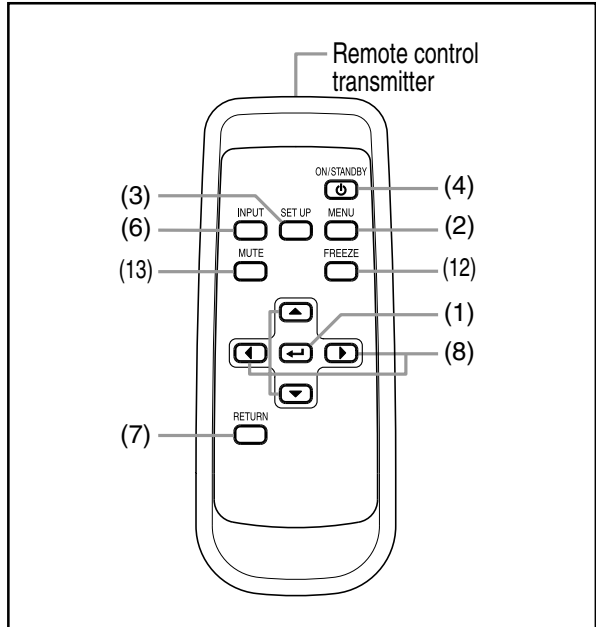

| Name | : Main Function |
|------|-----------------|
|------|-----------------|

- | | |
|-----------------------|---|
| (1) ENTER button | : Accepts the selected mode. |
| (2) MENU button | : Displays menus. p.28 |
| (3) SET UP button | : Sets up image and mode. p.25 |
| (4) ON/STANDBY button | : Turns the power on/off (standby). p.21 |
| (5) ON indicator | : Displays whether power is on or off. p.21 |
| (6) INPUT button | : Selects input. p.23 |
| (7) RETURN button | : Goes back one screen. |
| (8) Selection button | : Menu selections and adjustments, etc. p.29 |
| (9) LAMP indicator | : Displays lamp mode. p.22 |
| (10) TEMP indicator | : Lights when internal temperature too high. p.36 |
| (11) FAN indicator | : Displays cooling fan mode. p.36 |
| (12) FREEZE button | : Pauses image. p.27 |
| (13) MUTE button | : Cuts off the picture temporarily. p.27 |

Note

- For the remainder of this manual, buttons are referred to as follows:
 Selection buttons ⇒ ; ENTER button ⇒

Parts on the rear panel

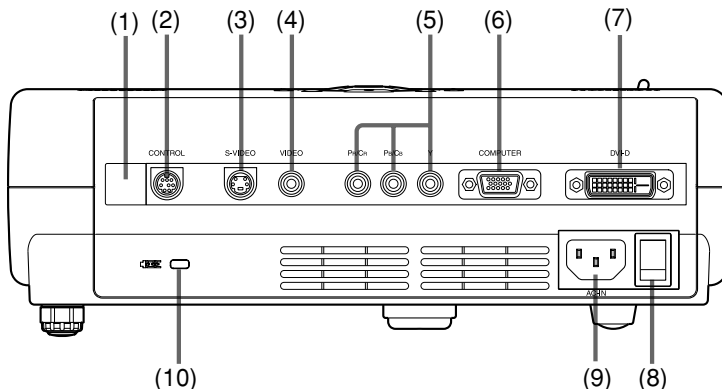

| Name | : Main Function |
|------------------------------|--|
| (1) Infrared remote sensor | : Senses commands from the remote control. p.18 |
| (2) CONTROL terminal | : When operating the projector via a computer, connect this to the controlling computer's RS-232C port. p.43 |
| (3) S-VIDEO terminal | : Input S video signals from video equipment. |
| (4) VIDEO terminal | : Input video signals from video equipment. |
| (5) Component video terminal | : Input component video signal (Y/Pb/Pr) from a video equipment or other source. |
| (6) COMPUTER terminal | : Input RGB signal from a computer or other source. |
| (7) DVI terminal | : Input digital RGB signal from a computer or other source. |
| (8) Main power switch | : AC power line ON (standby)/OFF. |
| (9) AC IN socket | : Connect the supplied power cord here. |
| (10) Antitheft lock hole | : Attach a safety cable or any other antitheft device. |

Notes

- Although this owner's manual abbreviates component video signals as Y/Pb/Pr, the product also supports signals from video equipment marked "Y/Cb/Cr."
- Input signal specifications for the DVI terminal complies with the DVI 1.0 Specifications.
- Please note that the operations for the functions not covered in these specifications are not guaranteed. Because this is an evolving technology, it is possible that some devices may not operate properly with the projector.
- This supports HDCP (High-bandwidth Digital Content Protection).

Preparing and using the remote control

■ Loading dry-cell batteries into the remote control

- ① Remove the battery cover.

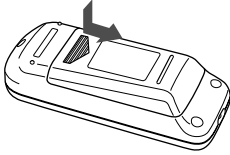

- ② Insert the dry-cell batteries.

Be sure to align the plus and minus ends of the batteries properly.

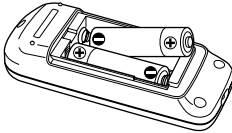

Two batteries (R6, SIZE AA) are used.

- ③ Replace the battery cover.

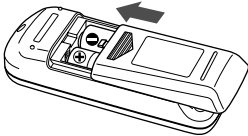

■ Operating the remote control

Point the remote control toward the projector's infrared remote sensor, and press a button on the remote control.

- Operating the projector from the front

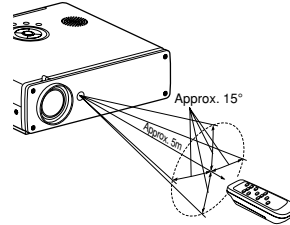

- Operating the projector from the rear

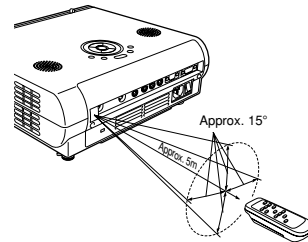

■ Dry-cell batteries

- Before using the batteries, be sure to observe the Safety Precautions described in previous pages.
- Remove batteries from remote control when not using for extended periods.
- If the remote control stops working, or if its range decreases, replace all the batteries with new ones.

■ The remote control

- The remote control may fail to operate if the infrared remote sensor is exposed to bright sunlight or fluorescent lighting.
- Do not drop or bang.
- Do not leave in hot or humid locations.
- Do not get wet or place on top of wet objects.
- Do not take apart.
- In rare cases, ambient conditions could impede the operation of the remote control. If this happens, point the remote control at the main unit again, and repeat the operation.

Placement

Placement Styles

As shown in the figures below, this device can be placed in 4 different styles. The factory setting is “floor-mounted front projection.” Set the **Projection mode** in the **default setting menu** [p.31](#), in accordance with your needs.

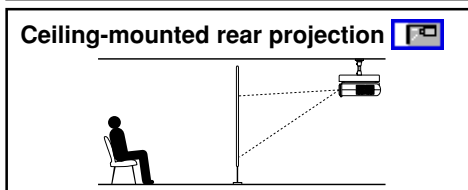
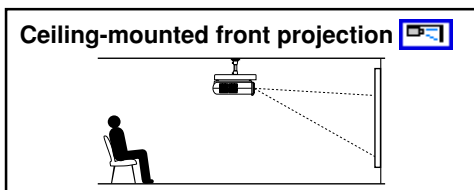
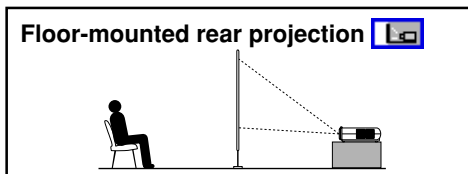
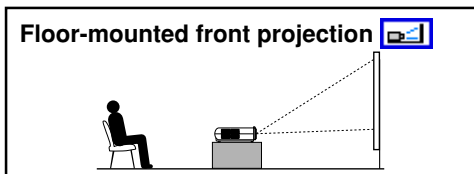

WARNING

- Always obey the instructions listed in IMPORTANT SAFETY INSTRUCTIONS when placing the unit. Attempting to clean/replace the lamp at a high site by yourself may cause you to drop down, thus resulting in injury.
- If you wish to mount the projector on the ceiling, be sure to ask your dealer to do so. Mounting the projector on a ceiling requires special ceiling brackets (sold separately) and specialized knowledge. Improper mounting could cause the projector to fall, resulting in an accident.
- If the projector is ceiling-mounted, install the breaker for turning off the power in case of anomaly. Let everyone involved with the use of the projector know that fact.

Projection Distance and Size

Use the figures, tables, and formulas below to determine the projection size and projection distance. (Projection sizes are approximate values for full-size picture with no keystone adjustment.)

Screen **As seen from above**

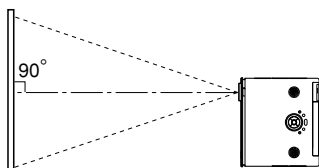

As seen from the side

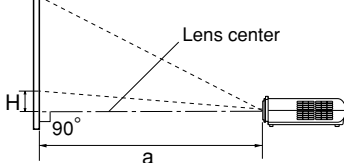

a is the distance (m) between the lens and the screen, and corresponds to a range of 1.20 m to 12.00 m. **H** is the height from the image bottom to the center of the lens.

$$a \text{ (min length)} = \text{projection size (inches)} \times 0.0414$$

$$a \text{ (max length)} = \text{projection size (inches)} \times 0.0498$$

| projection size (cm) | projection distance a (m) | | height (H) (cm) |
|----------------------|---------------------------|--------------------------|-----------------|
| | min length (zooming max) | max length (zooming min) | |
| 24.1 (61) | — | 1.20 | 16 |
| 40 (102) | 1.66 | 1.99 | 27 |
| 60 (152) | 2.48 | 2.99 | 40 |
| 80 (203) | 3.31 | 3.98 | 53 |
| 100 (254) | 4.14 | 4.98 | 67 |
| 150 (381) | 6.21 | 7.47 | 100 |
| 200 (508) | 8.28 | 9.96 | 134.4 |
| 290 (736) | 12.00 | — | 195 |

Connection

Before connection

- Read the owner's manual of the device you are connecting to the projector.
- Some types of computer cannot be used or connected to this projector. Check for an RGB output terminal, supported signal **p.39**, etc.
- Turn off the power of both devices before connecting.
- The figure below is a sample connection. This does not mean that all of these devices can or must be connected simultaneously. (Dotted lines mean items can be exchanged.)

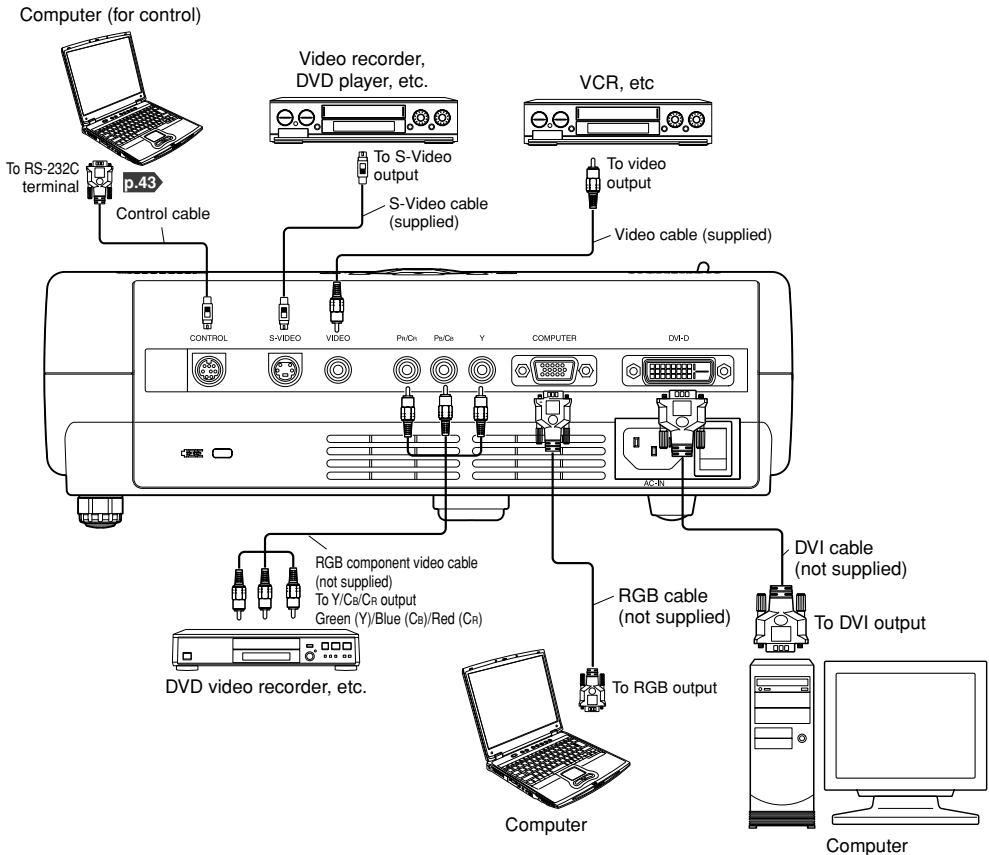

Notes

- If you want to feed the digital RGB signal, separately available DVI cable is needed.
- If you are using the digital RGB signal for input to this unit, some computer models or a certain type of DVI cable may cause on rare occasions noise on the screen. If such is a case, decrease your computer's refresh rate or the resolution. It is also recommended to use a DVI cable in 2 m or less in length.

■ Connecting the power cord

- 1 Insert the power cord connector into the AC IN socket of the projector.
- 2 Insert the power cord plug into a wall or other power outlet.

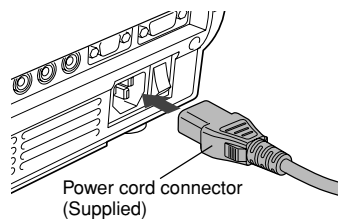

■ Removing the lens cover

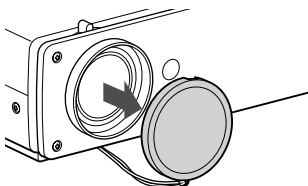

Be sure to remove the lens cover when the power is turned on. If it is left on, it could become deformed due to heat.

■ Turning the power on

1 Turn on the main power switch

The ON indicator will change to orange, indicating standby mode.

- After the main power switch is turned on, the inner cooling fan starts cooling.

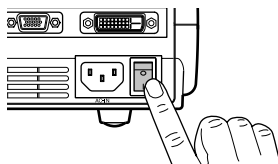

2 Press the ON/STANDBY button.

The power turns on, and the following 3 green indicators light: ON, LAMP, and FAN. After a moment, the start-up screen appears.

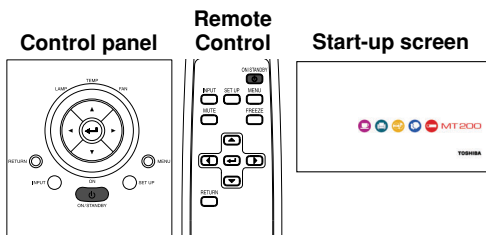

⚠ CAUTION

- Do not look into the lens while the lamp is on. The strong light from the lamp may cause damage to your eyes or sight.
- Do not block the air intake or exhaust. Doing so could cause a fire due to internal overheating.
- Do not place your hands, face, or other objects near the air exhaust. Doing so could cause burns, deform/break the object.

Turning the power on and off (Continued)

Notes

- The start-up screen will disappear after a moment. You can dismiss the start-up screen before this by performing any operation. You can also configure the start-up screen not to appear via the **Display setting menu** [p.30](#).
- The first time you use the projector after purchase, after the start-up screen disappears, the Language menu is displayed [p.23](#).

Turning the power off

1 Press the ON/STANDBY button.

A message appears on the screen, confirming that you wish to shut off the power. This message will disappear after a moment. (This operation is no longer valid after the message disappears.)

2 Press the ON/STANDBY button again.

The screen turns off, but the internal cooling fan continues to operate for a short while. Then, the projector goes into standby mode.

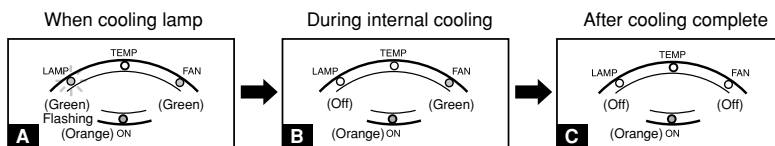

A During cooling, the LAMP indicator flashes. In this state, the power cannot be turned back on.

B After the LAMP indicator goes off, the cooling fan continues to operate for a short while, in order to expel excess internal heat. If you are in a hurry, there is no problem with unplugging the power cord or turning off the main power switch in this state.

C In standby mode

Note

- The projector consumes about 12W of power in standby. We recommend that you unplug the power cord or turn off the main power switch if you will not be using the projector for an extended period.

PRECAUTION

- If the power cord is unplugged before cooling is complete, give the lamp time (about 5 minutes) to cool before plugging it back in. If the lamp overheats, it may fail to light, and its lifetime will be shortened.

Basic operations

1 Turn on the power.

Turn on the power by following the instructions in “Turning the power on” [p.21](#).

2 Select the language and the lamp power (When using the first time).

When the projector is used for the first time after purchase, menu for language and lamp power selection and configuration is displayed in English. (If the screen is out of focus, adjust it according to the step [6](#).)

① Use the **▲** or **▼** button to select the desired language and press the **⊞** button.

Message for setup confirmation is displayed in a selected language.

Then, the menu for lamp power selection and configuration is displayed. It is automatically set as Standard. To change the setting, follow the step [2](#).

② Using the **▲** or **▼** button, select the lamp power and press the **⊞** button.

The lamp power, if selected, will be toggled without pressing the **⊞** button. The display automatically disappears in a few seconds.

| | |
|-----------|-----------------------|
| English | English |
| Français | French |
| Deutsch | German |
| Italiano | Italian |
| Español | Spanish |
| Português | Portuguese |
| Русский | Russian |
| Svenska | Swedish |
| Türkçe | Turkish |
| 日本語 | Japanese |
| 中文(简体字) | Chinese (simplified) |
| 中文(繁體字) | Chinese (traditional) |
| 한국어 | Korean |

■ Notes

- When the projector is turned on the next time, the Language and Lamp power menus do not appear upon startup. However, if “Reset all” is executed from the **Default setting** menu [p.31](#), the Language and Lamp power menus will be displayed the next time when the power is turned on.
- The language can also be set via the Display setting menu [p.30](#) and Lamp power via the Default setting menu [p.31](#).
- This owner’s manual assumes that English has been selected.

3 Activate the connected device.

Turn on and start the connected device such as a computer.

4 Press the INPUT button.

An image of the connected equipment is projected.

Each time you press the INPUT button, it switches to the input of the connected equipment.

■ Notes

- When [Auto input search] is set to [On] in the **default setting menu** [p.31](#), the image of the equipment which is connected and turned on is projected.
- Moving pictures generated with the DVD software for computers may appear unnatural if it is projected with this projector, but it is not a malfunction.

Basic operations (Continued)

5 Projector placement angle adjustments

The placement angle and the height of the projected image can be adjusted by the foot adjuster.

- 1 **Lift up the front of the projector to the desired angle, then press the foot adjuster release button.**

The foot adjuster extends. Release the button to lock the position.

- 2 **To adjust the horizontal angle, use the tilt adjuster.**

To stow the foot adjuster, hold up the projector while pressing the foot adjuster release button, then slowly lower the projector.

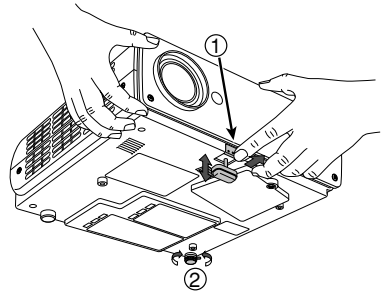

6 Adjusting the screen size and focus

- 1 **Use the zooming lever to adjust the screen size.**
- 2 **Use the focusing lever to adjust the focus.**

Readjusting the projection size with the zooming lever after focusing will cause the projected image to be out of focus. In that case, perform focusing again.

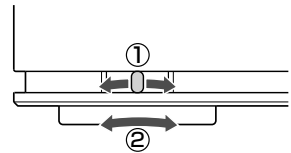

Notes

- Note that a lamp characteristics may rarely cause the brightness to fluctuate slightly.
- A lamp is consumable item. If used for extended periods, images will appear dark, and the lamp could burn out. This is characteristic of a lamp, and is not malfunction. (The lifetime of the lamp depends on conditions of use.)
- The DMD™ is made using extremely advanced technology, but there may be black spots (pixels that do not light) or bright spots (pixels that are constantly lit) on the panel. Please note that these are not malfunctions.
- Although this projector supports a wide range of RGB signals [p.39](#), any resolutions will be expanded or shrunk, which will affect image quality slightly.
- With some models of computer having LCD displays or the like, displaying images simultaneously on the projector and the monitor's display may prevent the images from displaying properly. If this happens, turn off the computer's LCD display. For information on how to turn off the LCD display, see the owner's manual of your computer.
- If a signal not supported by the projector is input, the "Unsupported signal" will appear.
- If no signal is being input from the connected device, the "No signal" will appear.
- If an unavailable operation button is pressed, the  icon will appear.

Using handy features

■ Using auto setting

This function sets up the projector to the optimum state for each type of the input signal by using simple operations.

❶ Press the SET UP button.

The Set up menu appears.

❷ Press the SET UP button again.

The displayed menu item is automatically adjusted/set.

For computer input, the  icon will appear during processing.

For manual adjustment and setting, see the following table [p.26](#).

Control panel

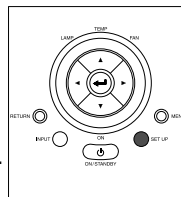

Remote Control

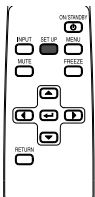

■ Notes



- The image may not be projected or auto adjustment/setting may not be performed correctly for input signals other than those supported by the projector [p.39](#), [p.40](#), [p.41](#).
- Keystone adjustment cannot be corrected automatically.

● Correcting the keystone distortion

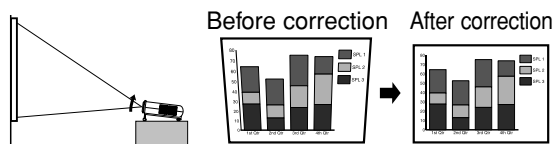
When the foot adjuster [p.24](#) is used to change the projector placement angle while projecting the image, the picture will undergo keystone (trapezoidal) distortion. This projector is capable of correcting this keystone distortion.



● Manual adjustment

Press the SET UP button to display the Set up menu and select [**Keystone**]. Use the   buttons for keystone adjustment. When the adjustment is finished, press the RETURN button. The menu disappears.

■ Notes

- Depending on the amount of keystone adjustment and the content of images, some information may be lost, or the picture quality may suffer.
- Keystone adjustment is available for the keystone distortion in a slant angle of ± 15 degrees.
- Keystone adjustment will not change the shape of the menus, the start-up screen, and the background (with no signal input).

Using handy features (Continued)

● Manual adjustments and settings

The menu items of the Set up menu vary depending on the input type, as shown in the table below.

Use the buttons to adjust the items in the table below, then press the RETURN button when you are finished.

| Select Item | Description | Computer | Y/Pb/Pr | Video S-video | DVI |
|---------------------------|--|----------|---------|---------------|-----|
| Keystone | Correct the keystone (trapezoid) distortion of the screen. Screen shrinking Screen shrinking downward upward | Yes | Yes | Yes | Yes |
| Auto setting | Automatically adjusts items such as the sampling phase depending on the type of input signal. Press the SET UP button. | Yes | No | No | No |
| Phase | Adjust with to eliminate flicker. | Yes | No | No | No |
| Frequency | Adjust with to eliminate periodic patterns and flickering when many vertical lines appear on the screen. | Yes | No | No | No |
| Image's H-position | Adjust the horizontal position of the image. Move left Move right | Yes | No | No | No |
| Image's V-position | Adjust the vertical position of the image. Move down Move up | Yes | No | No | No |
| Clamp 1 | Adjusts the clamp pulse position. Lower Higher | Yes | No | No | No |
| Clamp 2 | Adjusts the clamp pulse width. Narrower Wider | Yes | No | No | No |

■ Cutting off the picture temporarily (Mute)

When you want to project the images of another projector, overhead projector, etc. temporarily, this projector's images can be turned off.

● Press the remote control's MUTE button.

The picture is cut off. (The Mute function is released when pressing the MUTE button again.)

■ Notes

- The  icon will appear while mute is in effect.
- Operating any other functions will also cancel the muting.

■ Freezing the image (Freeze)

The image being projected can be frozen. This function is to be used to pause a video during a presentation, etc.

● Press the remote control's FREEZE button.

The picture pauses. (The Freeze function is released when pressing the FREEZE button again.)

■ Notes

- The  icon will appear while freeze is in effect.
- Other operation will also release the freeze.
- Even if an image is frozen on the projector, the pictures are running on the video or other equipment.
- If you use this function on video software sold on the market, broadcast or broadcast on cable except for the purpose of your private viewing and listening, it may infringe the copyright protected by the copyright laws.

Remote Control

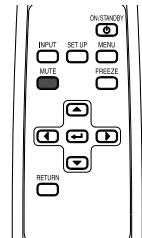

Remote Control

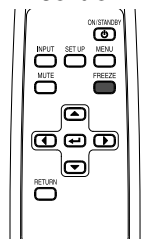

Using the menus

You can call up on-screen menus, and conduct a number of adjustments and settings using the operation buttons **p.16** on the control panel (main unit side) and remote control.

■ How to use the menus





The menu shown below is for operation instructions purposes and might differ from the actual display.

1. Press the MENU button Display the **Setting display** menu

2. Select a Category

Select a category by using .

There are following four categories:

-  **Image adjustment menu** **p.29**
-  **Display setting menu** **p.30**
-  **Default setting menu** **p.31**
-  **Status display menu** **p.32**





Displays the current adjustments and settings of selected category. Item shown with gray cannot be adjusted with the current input source.

3. Adjustments & Settings

Press  to open the menu.

Brightness adjustment: Shows a slider with '12' and '100' markers. A callout box says: "These marks signify the items can be adjusted/set by using .

Language selection: Shows a list of languages with 'English' selected. A callout box says: "This mark signify that there are options. Press  to display a list of options."

Language list: Shows a scrollable list of languages including English, Français, Deutsch, Italiano, Español, Português, Русский, Svenska, Türkçe, 日本語, 中文(简体字), 中文(繁體字), and 한국어. A callout box says: "These marks signify the items can be selected from the list by using . After an item is selected, apply it by pressing .

The figure shows displays given for operation instructions purposes. As the display may differ depending on the item, use the following pages as a reference.

5. End
Press the MENU button
The menu disappears.

4. Back
Return button





































■ Note

- Menu adjustments and settings are saved when the power is turned off via the **ON/STANDBY** button. If the power cable is disconnected before this, or the power goes out, then the data will not be saved.

■ The image adjustment menu

Use this menu to adjust image-related items.

Items that can be adjusted are marked with “Yes”, and those that cannot are marked with “No”.









| Item   | Description | Computer | Y/Pb/Pr | Video S-video | DVI |
|--|--|----------|---------|---------------|-----|
|  Contrast | Adjust the image contrast. Lower   Higher | Yes | Yes | Yes | Yes |
|  Brightness | Adjust the brightness of the image. Darker   Brighter | Yes | Yes | Yes | Yes |
|  Color | Adjust the color of the image. Lighter   Deeper | No | Yes | Yes | No |
|  Tint *1 | Adjust the tint of the image color. Reddish   Greenish | No | No | Yes | No |
|  Sharpness | Adjust the sharpness of the image. Softer   Sharper | No | Yes | Yes | No |
|  Noise reduction | Set the function to reduce screen noise. On (Enable)   Off (Disable) | No | Yes | Yes | No |
|  Picture mode | Press  . Toggle the picture mode with  /  . Dynamic/Standard/Theater | Yes | Yes | Yes | Yes |
|  R-level | Adjust red of the image color. Less red   More red | Yes | Yes | Yes | Yes |
|  G-level | Adjust green of the image color. Less green   More green | Yes | Yes | Yes | Yes |
|  B-level | Adjust blue of the image color. Less blue   More blue | Yes | Yes | Yes | Yes |
|  NTSC mode *1 | Set the black level with  /  button. US: NTSC (US) mode Japan: NTSC (JAPAN) mode | No | No | Yes | No |

*1: [Tint] and [NTSC mode] can be displayed and adjusted only when the video signal is set to [NTSC] and [NTSC4.43]. (NTSC mode is set to JAPAN when the language is set to Japanese. It is set to US for other languages.)

Using the menu (Continued)

■ The display setting menu

Use this menu to set screen display-related items.





| Item ▲▼ | Description |
|--|--|
|  Screen size | Full ◀▶ 4:3 ◀▶ Zoom Full : This mode is best for squeeze-signal video images. 4:3 : This mode is best for 4:3-signal video images on the 4:3-size screen. Zoom : This mode is best for video images of letter-box or cinema signals. |
|  Language | Select one of the languages below to use for displaying the menu and messages [Enter setting mode] → [Selection] → [Apply:] English/Français/Deutsch/Italiano/Español/Português/Русский/ Svenska/Türkçe/ 日本語 / 中文(簡体字) / 中文(繁体字) / 한국어 |
|  Background | Screen to display when there is no input signal  (Logo) ◀▶  (Blue) ◀▶  (Black) |
|  Icon | Display icons as function guides On ◀▶ Off |
|  Start-up screen | Display start-up screen when power is turned on On ◀▶ Off |

● Screen size

The screen size of this unit is 16:9, but the screen size can be changed according to the input signal.

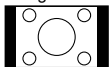
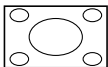
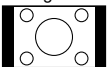
■ Note

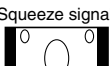
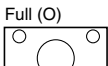
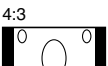
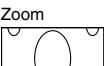
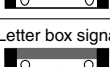
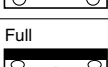
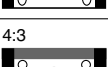
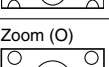
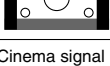
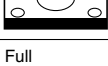
- Using these functions to change the picture size (i.e., changing the height/width ratio) for any purpose other than your private viewing may be prohibited under the Copyright Laws of the United States and other countries, and may subject you to civil and criminal liability.

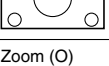
| Input signal | Projection screen | | |
|---|---|---|---|
|  |  |  |  |
|  |  |  |  |
|  |  |  |  |
|  |  |  |  |













(O): Optimum screen size

■ Notes

- The screen size cannot be changed when the 16:9 signal is input.
- You cannot select "Zoom" when the input is COMPUTER or DVI.

■ The default setting menu

This menu shows placement status and other settings.

| Item ▲ ▼ | Description |
|---|---|
|  Projection mode | Sets projection mode in accordance with Placement Style. p.19  (Standard) ◀ ▶  (Rear) ◀ ▶  (Mounted from ceiling) ◀ ▶  (Rear mounted from ceiling) |
|  No signal power off | Set the timer to wait for the power to be turned off after signal input stops. Press  . Switch with ▲ and ▼. Off (not turned off)/1 min./5 min./10 min./30 min./60 min. |
|  Auto input search | Set whether the input with signals is only selected or not. On ◀ ▶ Off |
|  Power on | Sets whether to turn on the power when the ON/STANDBY button is pressed (Manual), or when the power cord is plugged in (Auto). Manual ◀ ▶ Auto |
|  Lamp power <small>[Note 1]</small> | Sets the lamp power. Low ◀ ▶ Standard |
|  Fan mode <small>[Note 2]</small> | Sets the cooling fan speed. Standard ◀ ▶ High |
|  Reset all | Press  . Resets all adjustments and settings to their factory settings. Yes ◀ ▶ No |

Notes

- 1: When **Lamp power** is set to **Low**, the screen becomes a little darker, but the cooling fan noise gets quieter. This setting will be cleared when you turn the power off.
- 2: Setting **[Fan mode]** to **[High]** increases the cooling fan speed. Set this option to use the projector, for example, at high altitude (over 1,500 meters above sea level).

■ Notes

- Note that in the event of a power outage but the power is restored afterwards, the projector power will come on if **Power on** is set to **Auto**, and the power cord is plugged in.
- When you turn off the projector even if **Power on** is set to **Auto**, you must press the **ON/STANDBY** button to turn the power off.

Using the menu (Continued)

■ Displaying Information (Status display)

This displays information about the input signal, lamp use time, etc.

“Yes”: displayed, “No”: not displayed

| Item | Description | Computer | Y/P _B /P _R | Video S-video | DVI |
|------------------|--|----------|----------------------------------|---------------|-----|
| Input | Input source name | Yes | Yes | Yes | Yes |
| Mode name | RGB input mode ^[Note 1] | Yes | No | No | Yes |
| H-resolution | Horizontal resolution (in dots) | Yes | No | No | Yes |
| V-resolution | Vertical resolution (in dots) | Yes | No | No | Yes |
| H-frequency | Horizontal sync frequency | Yes | No | No | Yes |
| V-frequency | Vertical sync frequency ^[Note 2] | Yes | No | No | Yes |
| Sync | Sync signal polarity ^[Note 3] | Yes | No | No | Yes |
| Signal format | Y/P _B /P _R signal format | No | Yes | No | No |
| Video mode | Color method of video signal | No | No | Yes | No |
| Lamp time | Time of lamp use ^[Note 4] | Yes | Yes | Yes | Yes |
| Lamp reset count | The count for lamp replacement | Yes | Yes | Yes | Yes |
| Total time | The total time that this projector is used | Yes | Yes | Yes | Yes |
| Version | Firmware version ^[Note 5] | Yes | Yes | Yes | Yes |

Notes

- 1: The mode of supported RGB signals **p.39** is shown.
- 2: Same as the refresh rate of the computer signal.
- 3: Sync signal polarity shown as P (positive) or N (negative) for [H/V].
- 4: Displays [**Lamp time**] as a measure of when the lamp should be replaced. (Cannot be used as a counter of guaranteed lamp time.) When the displayed time approaches 2,000 hours, consult with a store about getting a TLPLMT20 replacement lamp (sold separately) prepared.
- 5: [**Version**] shows the version of the projector's internal control program. This version is referred to for customer service, etc.

■ Note

- The displayed information will not be refreshed if the status changes. To refresh the information, dismiss the display, then display it again.

About lamp

The product's light source is a mercury lamp that lights at increased internal pressure. Be sure to fully understand the following characteristics of the lamp and handle it with extreme care.

- The lamp may explode with a loud noise due to impact or deterioration, or fail to light at the expiration of its life.
- How long it takes before the lamp explodes or the life expires may vary greatly by lamp. Some may explode shortly after first use. (Free replacement is available if the lamp explodes within the warranty period. Contact the dealer from whom you purchased the product in such a case.)
- Lamp rupture is more likely to happen if the lamp is used after the recommended replacement period has elapsed.
- When the lamp explodes, the broken pieces of glass may get inside the product or be released outside from the openings for ventilation.
- When the lamp explodes, a slight amount of mercury gas enclosed in the lamp along with glass dust may be released from the openings for ventilation.

■ Immediately replace the lamp when a sign appears on the screen.

- When the replacement time approaches, a message will appear on the screen.
- The risk of explosion will increase if the lamp is continuously used without being replaced.
- Frequently check the used hours and prepare spares when the replacement time approaches. (Refer to "Status display". [p.32](#))

■ When the lamp is broken

- If glass components, including a lamp and a lens, should break, handle the broken pieces with care to avoid injury and contact your dealer for repair service.
- In the event of lamp explosion, unplug the product from the wall outlet, leave and completely ventilate the room. Then, thoroughly clean the area around the projector and discard any edible items placed in that area.

Lamp replacement

A lamp is consumable supplies. If used for extended periods, images will appear dark, and the lamp could burn out. This is characteristic of a lamp, and is not malfunction. (The lifetime of the lamp depends on condition of use.) If this happens, replace it with a new one.

WARNING

- If the projector is mounted on a ceiling, request a lamp replacement from your projector dealership.
- When replacing, always use lamp "TLPLMT20" (sold separately).

CAUTION

- If you have been using the projector, the lamp will be very hot, and may cause burn injuries. Wait for the lamp to cool (for longer than 1 hour) before replacing it.
- If the lamp should break, please handle with care to avoid injury due to broken pieces and contact your dealer for repair service.

Lamp replacement (Continued)

1 Unplug power cord.

2 Wait until lamp is sufficiently cooled.

Wait for at least 1 hour.

3 Remove the lamp cover.

Loosen the 1 screw, then pull up to the direction of the arrow with your fingers as shown to remove the lamp cover. Use care to avoid any damage to nails and/or tip of your finger(s). If you have any difficulty in removal, you can use a screwdriver or any other smaller tool for your convenience.

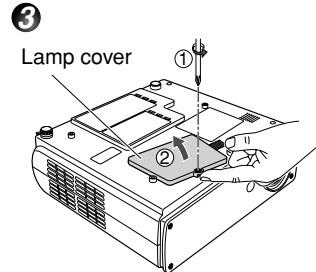

4 Pull out the lamp.

Loosen the 2 screws holding the lamp in place, and pull up the handle to remove the lamp.

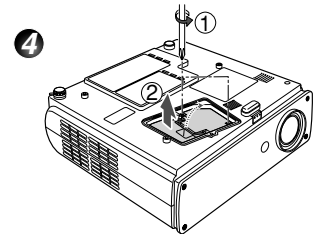

5 Mount the new lamp.

Align the orientation, press down until the bottom is reached, and lock in place using the two lamp locking screws.

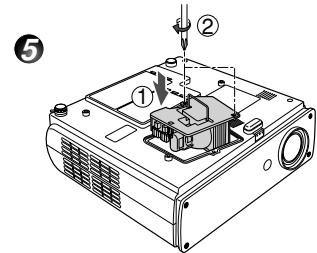



6 Replace the lamp cover.

Align the cover, and press it in, then tighten the screws loosened in step 3 until the lamp cover is no longer loose.

7 Reset the lamp timer.

See the lamp's manual for instructions on resetting the lamp timer.

Notes and Precautions

- Press the  button twice to display (a rough guide) the time of lamp use, the **Lamp time** item, in the **Status display menu**. [p.32](#)
- It is recommended that the lamp be replaced after 2,000 hours of use. When **Lamp time** reaches 2,000 hours, the  icon and a message will appear. This display disappears when you press  button.
- Attach the lamp cover correctly so that it is not loose. If it is not attached correctly, the lamp may fail to come on [p.36](#), and the lamp's lifetime may be shortened.
- Always replace the lamp with a new one.
- The lamp is made out of glass. Do not touch the glass surface with your bare hands, bang it, or scratch it. (Dirt, jolts, scratches and the like could break the lamp.)

■ Used Lamps

This projector's lamps contain trace amounts of environmentally harmful inorganic mercury. Be careful not to break used lamps, and dispose of them in accordance with local regulations.

Lens and main unit cleaning

⚠ WARNING

- Request cleaning and maintenance of a ceiling-mounted unit from your projector dealership. Attempting to clean/replace the lamp at a high site by yourself may cause you to fall down, thus resulting in injury.

■ Lens cleaning

- Clean the lens with a commercially available blower and/or lens cleaner.
- The lens is easily scratched, so do not rub it with hard objects, or strike it.

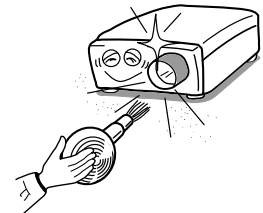

■ Main unit cleaning

- Clean the main unit after unplugging the power cord.
- Wipe dirt off the main unit gently with a soft cloth.
- If the soiling is severe, dip the cloth in a neutral detergent diluted in water, wring well, and gently wipe off the dirt, then finish up by wiping with a dry cloth.

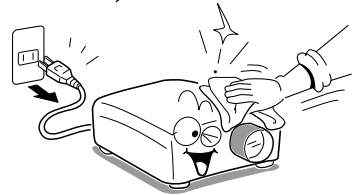





● Replacing cooling fans

To maintain the performance, it is recommended that cooling fans should be replaced about every 2 to 3 years. Consult with your dealer for details.

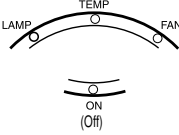
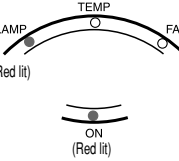
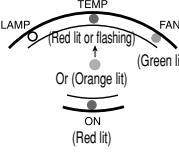
Trouble indications

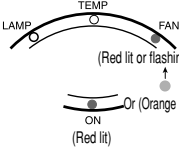
The indicator lights inform you of internal abnormalities.

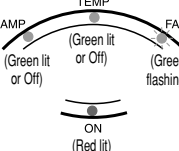
| | |
|--|---|
|  | <p>No power</p> <p>⇒ Problem with projector</p> <ul style="list-style-type: none"> • Unplug the power cord, and contact your dealer. <p>⇒ The lamp cover is not properly attached.</p> <ul style="list-style-type: none"> • Unplug the power cord, and reattach the lamp cover. p.34 |
|  | <p>Lamp went out during use, or won't come on</p> <p>⇒ Lamp temperature is high so that it is difficult to turn on, the lifetime of the lamp has ended or the projector is malfunctioning.</p> <ul style="list-style-type: none"> • Unplug the power cord and wait for a short while, then turn the power back on. • If a lamp burns out, replace it with a new one. <p>* After approx. one minute of abnormal display, the projector returns to the standby state waiting for internal cool down.</p> |
|  | <p>Power went out during use</p> <p>⇒ Internal overheating, or the outside temperature is too high.</p> <ul style="list-style-type: none"> • Place the projector so that the air intake and exhaust are not blocked. • Unplug the power cord and wait for a short while, then turn the power back on. <p>* The  icon will appear before the power goes out.</p> <p>* After approx. one minute of abnormal display, the projector returns to the standby state waiting for internal cool down.</p> |
|  | <p>Power went out during use</p> <p>⇒ Problem with internal cooling fan.</p> <ul style="list-style-type: none"> • Unplug the power cord, and contact your dealer. <p>* The  icon will appear before the power goes out.</p> <p>* After approx. one minute of abnormal display, the projector returns to the standby state waiting for internal cool down.</p> |
|  | <p>Power went out during use</p> <p>⇒ Problem inside the projector.</p> <ul style="list-style-type: none"> • Unplug the power cord and wait for a short while, then turn the power back on. • If the above action will not clear the problem, unplug the power cord, and contact your dealer. <p>* After approx. one minute of abnormal display, the projector returns to the standby state waiting for internal cool down.</p> |

PRECAUTION

- Make sure to unplug the power cord if something goes wrong.

Before calling service personnel

If you think something is wrong, check the followings before contacting customer service. Please see “**Trouble indications**” [p.36](#) as well.

| If This Happens | Check |
|---|---|
| No power | <ul style="list-style-type: none"> • Is the power cord plugged in? Is it connected to the projector? • Is the lamp cover loose? p.34 |
| Power goes out during use | <ul style="list-style-type: none"> • Is the ambient temperature high? p.36 • Is the air intake or air exhaust blocked? p.36 |
| No picture | <ul style="list-style-type: none"> • Is the projector turned on? p.23 • Is the mute function on? p.27 • Is the brightness setting minimized? p.29 • Are the connections set up correctly? p.20 • Are all the connected devices functioning properly? |
| Picture not displayed correctly | <ul style="list-style-type: none"> • Is the input signal supported by the projector? p.39 , p.40 , p.41 • Is there something generating an abnormal video signal, for instance the video tape? |
| Picture blurred Part of picture out of focus | <ul style="list-style-type: none"> • Is the lens dirty? p.35 • Is the lens focus adjusted optimally? p.24 • Is the projection distance within the projector's supported range? p.19 • Is the projector's screen placement angle tilted too far? p.19 • Are the sharpness or sampling phase adjustments off? p.26 p.29 |
| Image is dark | <ul style="list-style-type: none"> • Are the brightness or contrast adjustments off? p.29 • Is the lamp nearing the end of its service life? p.32 |
| Colors too light Bad shading | <ul style="list-style-type: none"> • Are the color, tint, R-level, G-level, or B-level adjustments off? p.29 • Is the screen dirty? • Is the lamp nearing the end of its service life? p.32 |
| Remote control doesn't work | <ul style="list-style-type: none"> • Are the remote control's batteries drained? • Are the batteries inserted into the remote control correctly? p.18 • Is the remote control being used within the effective range? p.18 • Are there any obstructions between the remote control and projector? • Are there any fluorescent or other bright lights shining at the projector's infrared remote sensor? |

Specifications

■ List of general specifications

| Item | Specification | |
|---|--|-------------------------------|
| Consumption Power | 300 W | |
| Weight | 2.8 kg | |
| External Dimensions (including protruding parts) | 298 × 101.4 × 275.4 mm (W × H × D) | |
| Cabinet material* | PC+ABS resin and ABS resin | |
| Conditions for usage environment | Temp: 5°C to 35°C; relative humidity: 30% to 70% | |
| Display pixels | 1 chip DMD™ | |
| Picture elements | 409,920 pixels (854H × 480V) | |
| Lens | Zoom lens F=2.75-3.03 f=22.3-26.76 mm | |
| Lamp | High-pressure mercury lamp | |
| Projection screen size | 24-290 inches | |
| Projection distance | 1.20-12.00m | |
| Connection terminal | COMPUTER terminal | Mini D sub 15 pin Analog RGB |
| | DVI-D terminal | DVI connector Digital RGB |
| | Y terminal | RCA Pin Jack, 1V(p-p), 75 Ω |
| | Pb/Cb terminal | RCA Pin Jack, 0.7V(p-p), 75 Ω |
| | Pr/CR terminal | RCA Pin Jack, 0.7V(p-p), 75 Ω |
| | VIDEO terminal | RCA Pin Jack, 1 V (p-p), 75 Ω |
| | S-VIDEO terminal | Mini DIN 4 pin |
| | CONTROL terminal | Mini DIN 8 pin (RS-232C) |

■ Note

- This model complies with the above specifications.
- Designs and specifications are subject to change without notice.
- This model may not be compatible with features and/or specifications that may be added in the future.

■ Separately sold product

Replacement Lamp Model TLPLMT20

■ List of supported signals (RGB signals)

This projector supports the following RGB signals. Note, however, that depending on the computer model, the screen may show flicker or streaking. Please adjust the projector if this happens.

(Press the SET UP button, and adjust automatically or manually. [p.25](#) , [p.26](#))

| Resolution | Mode | Refresh rate (Hz) | H-frequency (kHz) | Clock (MHz) |
|-------------|------------|-------------------|-------------------|-------------|
| 720 x 400 | 720x400_85 | 85.039 | 37.927 | 35.500 |
| 640 x 480 | VGA_60 | 59.940 | 31.469 | 25.175 |
| | VGA_72 | 72.809 | 37.861 | 31.500 |
| | VGA_75 | 75.000 | 37.500 | 31.500 |
| | VGA_85 | 85.008 | 43.269 | 36.000 |
| 800 x 600 | SVGA_56 | 56.250 | 35.156 | 36.000 |
| | SVGA_60 | 60.317 | 37.879 | 40.000 |
| | SVGA_72 | 72.188 | 48.077 | 50.000 |
| | SVGA_75 | 75.000 | 46.875 | 49.500 |
| | SVGA_85 | 85.061 | 53.674 | 56.250 |
| 832 x 624 | MAC16" | 74.550 | 49.725 | 57.283 |
| 1024 x 768 | XGA_60 | 60.004 | 48.363 | 65.000 |
| | XGA_70 | 70.069 | 56.476 | 75.000 |
| | XGA_75 | 75.029 | 60.023 | 78.750 |
| | XGA_85 | 84.997 | 68.667 | 94.500 |
| | MAC19" | 74.700 | 60.134 | 79.857 |
| 1152 x 864 | SXGA1_75 | 75.000 | 67.500 | 108.000 |
| 1280 x 960 | QuadVGA_60 | 60.000 | 60.000 | 108.000 |
| | QuadVGA_85 | 85.002 | 85.938 | 148.500 |
| 1280 x 1024 | SXGA3_60 | 60.020 | 63.981 | 108.000 |
| | SXGA3_75 | 75.025 | 79.976 | 135.000 |
| | SXGA3_85 | 85.024 | 91.146 | 157.500 |
| 1400 x 1050 | SXGA+ | 60.012 | 63.973 | 118.094 |

■ Note

- Signals which resolution exceeds the native resolution (854 × 480 pixels) will be compressed. For this reason, some information may be lost, or image quality may be affected.

Specifications (Continued)

■ List of supported signals (DVI signals)

This projector supports the following DVI signals. Note, however, that depending on the computer model, the screen may show flicker or streaking. Please adjust the projector if this happens.

| Resolution | Mode | Refresh rate (Hz) | H-frequency (kHz) | Clock (MHz) |
|-------------|------------|-------------------|-------------------|-------------|
| 640 x 480 | VGA_60 | 59.940 | 31.469 | 25.175 |
| | VGA_72 | 72.809 | 37.861 | 31.500 |
| 800 x 600 | SVGA_60 | 60.317 | 37.879 | 40.000 |
| | SVGA_72 | 72.188 | 48.077 | 50.000 |
| 832 x 624 | MAC16" | 74.550 | 49.725 | 57.283 |
| 1024 x 768 | XGA_60 | 60.004 | 48.363 | 65.000 |
| | XGA_70 | 70.069 | 56.476 | 75.000 |
| | XGA_75 | 75.029 | 60.023 | 78.750 |
| 1152 x 864 | SXGA1_75 | 75.000 | 67.500 | 108.000 |
| 1280 x 960 | QuadVGA_60 | 60.000 | 60.000 | 108.000 |
| 1280 x 1024 | SXGA3_60 | 60.020 | 63.981 | 108.000 |

| Signal format | fh(kHz) | fv(Hz) |
|-------------------|---------|--------|
| 480p(525p)@60Hz | 31.47 | 59.94 |
| 576p(625p)@50Hz | 31.25 | 50.00 |
| 720p(750p)@60Hz | 45.00 | 60.00 |
| 720p(750p)@50Hz | 37.50 | 50.00 |
| 1080i(1125i)@60Hz | 33.75 | 60.00 |
| 1080i(1125i)@50Hz | 28.13 | 50.00 |

■ Note

- Signals which resolution exceeds the native resolution (854 × 480 pixels) will be compressed. For this reason, some information may be lost, or image quality may be affected.

■ List of supported signals (Y/P_B/P_R signals)

| Signal format | fh(kHz) | fv(Hz) |
|--------------------|---------|--------|
| 480i(525i) @60Hz | 15.73 | 59.94 |
| 480p(525p) @60Hz | 31.47 | 59.94 |
| 576i(625i) @50Hz | 15.63 | 50.00 |
| 576p(625p) @50Hz | 31.25 | 50.00 |
| 720p(750p) @60Hz | 45.00 | 60.00 |
| 720p(750p) @50Hz | 37.50 | 50.00 |
| 1080i(1125i) @60Hz | 33.75 | 60.00 |
| 1080i(1125i) @50Hz | 28.13 | 50.00 |

■ List of supported signals (Video, S-Video signals)

| Video mode | fh(kHz) | fv(Hz) | fsc(MHz) |
|------------|---------|--------|--------------|
| NTSC | 15.73 | 60 | 3.58 |
| PAL | 15.63 | 50 | 4.43 |
| SECAM | 15.63 | 50 | 4.25 or 4.41 |
| PAL-M | 15.73 | 60 | 3.58 |
| PAL-N | 15.63 | 50 | 3.58 |
| PAL-60 | 15.73 | 60 | 4.43 |
| NTSC4.43 | 15.73 | 60 | 4.43 |

■ Pin assignment of COMPUTER terminal

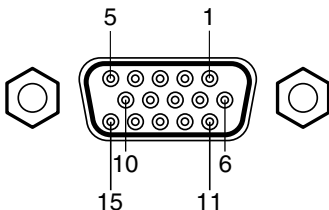

Mini D sub 15 Pin connector

Input Signal

• RGB input

- RGB signals: 0.7V (p-p) 75 Ω
- Horizontal sync signal: TTL level (Pos/neg polarity)
- Vertical sync signal: TTL level (Pos/neg polarity)

| Pin No. | Pin description |
|---------|------------------------|
| 1 | Video signal (R) |
| 2 | Video signal (G) |
| 3 | Video signal (B) |
| 4 | GND |
| 5 | GND |
| 6 | GND (R) |
| 7 | GND (G) |
| 8 | GND (B) |
| 9 | N.C |
| 10 | GND |
| 11 | GND |
| 12 | N.C |
| 13 | Horizontal sync signal |
| 14 | Vertical sync signal |
| 15 | N.C |

Specifications (Continued)

■ Pin arrangement for the DVI-D terminal

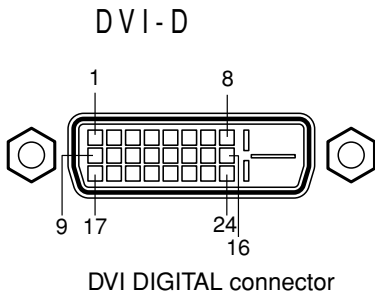

| Pin No. | Pin description | Pin No. | Pin description |
|---------|-----------------------------|---------|--------------------------|
| 1 | T.M.D.S. data 2- | 16 | Hot plug detection |
| 2 | T.M.D.S. data 2+ | 17 | T.M.D.S. data 0- |
| 3 | T.M.D.S. data 2/4 shield | 18 | T.M.D.S. data 0+ |
| 4 | T.M.D.S. data 4- | 19 | T.M.D.S. data 0/5 shield |
| 5 | T.M.D.S. data 4+ | 20 | T.M.D.S. data 5- |
| 6 | DDC clock | 21 | T.M.D.S. data 5+ |
| 7 | DDC data | 22 | T.M.D.S. clock shield |
| 8 | Analog vertical sync signal | 23 | T.M.D.S. clock+ |
| 9 | T.M.D.S. data 1- | 24 | T.M.D.S. clock- |
| 10 | T.M.D.S. data 1+ | | |
| 11 | T.M.D.S. data 1/3 shield | | |
| 12 | T.M.D.S. data 3- | | |
| 13 | T.M.D.S. data 3+ | | |
| 14 | +5V power supply | | |
| 15 | GND(+5V, H Sync & V Sync) | | |

■ CONTROL terminal

● Pin assignment

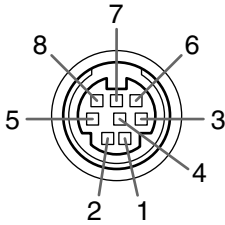

Mini DIN 8 pin connector

| Pin No. | Signal Name | Description |
|---------|-------------|-----------------|
| 1 | RXD | Receiving data |
| 2 | CTS | Consent to send |
| 3 | DSR | Data set ready |
| 4 | GND | Signal ground |
| 5 | RTS | Request to send |
| 6 | N.C | No connection |
| 7 | TXD | Sending data |
| 8 | GND | Signal ground |

● Interface format

- Communication method RS-232C, 9600bps, No Parity, Data Length: 8 bits;
Stop Bit Length: 1 bit
- Communication format

| | | |
|-----------|-----------------|-----------|
| STX (02h) | Command (3Byte) | ETX (03h) |
|-----------|-----------------|-----------|

Only 1 command valid per communication.
- Data format For input commands, only ASCII-compliant all-uppercase alphanumeric characters supported.
- Replies Acknowledge

| | | |
|-----------|----------|------|
| ACK (06h) | CR (0Dh) | Data |
|-----------|----------|------|

 ... Normally ended

| | |
|-----------|-----------|
| ACK (06h) | ESC (1Bh) |
|-----------|-----------|

 ... Aborted
 No acknowledge

| |
|-----------|
| NAK (15h) |
|-----------|

If commands are to be sent consecutively, wait for the response from the projector before sending the next command.

● Main Commands

| Item | Command |
|--------------------------|------------|
| Power on | PON |
| Power off | PSD |
| Icon display on | MO0 |
| Icon display off | MO1 |
| Auto setting (RGB input) | PAT |
| Status display on | DON |
| Status display off | DOF |

| Item | Command |
|--------------------------|------------|
| Computer input select | IN1 |
| DVI input select | IN2 |
| Video input select | IN3 |
| S-video input select | IN4 |
| YPB/CbPr/CR input select | IN5 |

■ Note

- Contact your dealer for control cable and other commands.

TOSHIBA CORPORATION